

QUADRODEC®

Quadrodec® Bend 90° round Ø160mm

Order code: QDRC90MM160

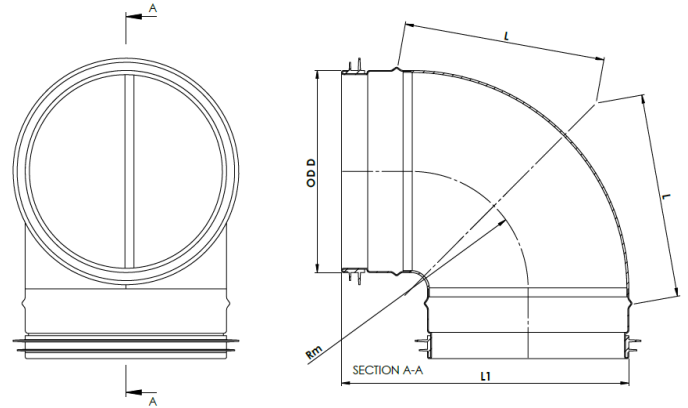

Description

Round bend 90°, Ø160mm with EPDM on both sides. Can be used universally for all round female connections with the same nominal diameter of the Quadrodec system.

Connection: Male/Male
Material: DX53D, Zinc plated 275g/m²
EN ISO 9227:2006

DEC®Safe connection: EPDM
IEC 60695-2-11:2014 (TÜV)
REACH, ROHS (TÜV)

Classification

EN 13501-1:2018: Class A1
EN 12237: Leakage Class D/(ATC2)
Ansi Ashrae 120-2017: Pressure loss

Leakage

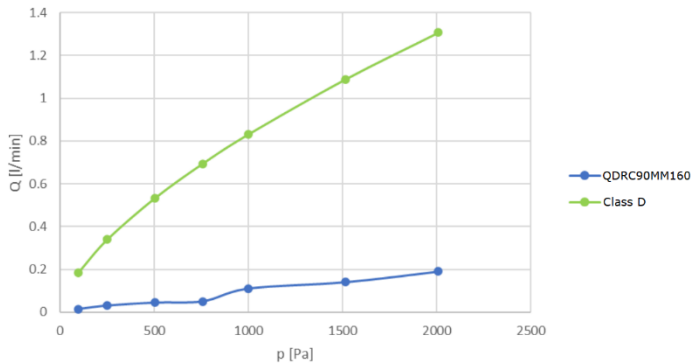

Also available in Ø125mm.

OD D	L	L1	Rm
mm	mm	mm	mm
159,3 -0,5/+0	143,3	212,3	89,65

Pressure loss

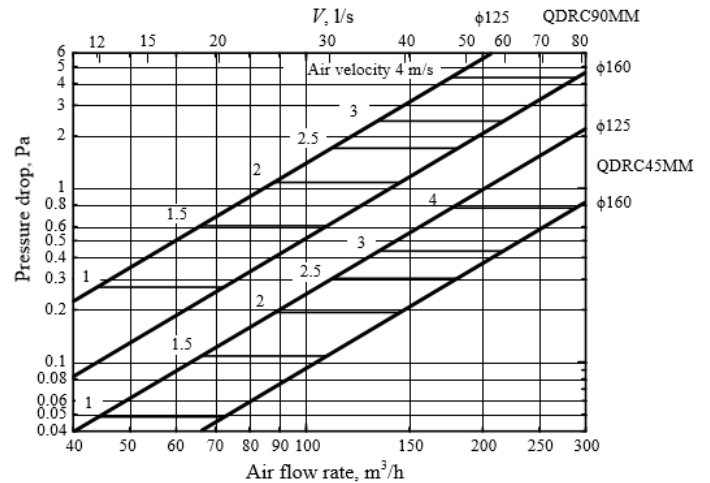

LIABILITY:

The information contained in this brochure was current on the publication date. DEC INTERNATIONAL reserves the right to make changes in details at any time without prior notice. In order to avoid misunderstandings, any interested party is advised to contact DEC INTERNATIONAL checking for any changes in materials and/or information after this brochure was published.

PLEASE NOTICE:

The consultant is responsible for the actual installation and mounting of the product. The mentioned values with respect to temperatures are not appropriate to be used to determine the physical properties. These properties are also dependent on humidity and the temperature of the air inside and outside of the H.V.A.C. system.

TRADEMARKS:

QUADRODEC, the DEC logo and DEC International are trademarks or registered trademarks of Dutch Environment Corporation BV in the Netherlands and/or other countries.

RESTRICTIONS:

The QUADRODEC ducts are not suitable for discharging combustion products from open fireplaces and oil-fired boilers. Neither are the ducts suitable for transporting air with a high concentration of acid and base.

